

3  
S2 BASE OF CU-409R

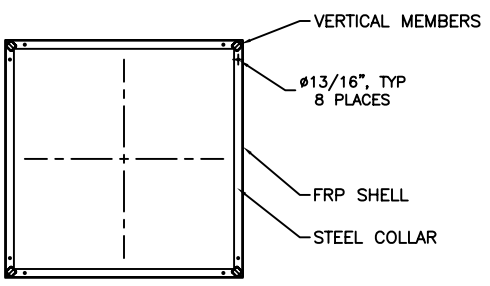

2  
S2 TOP OF CU-705

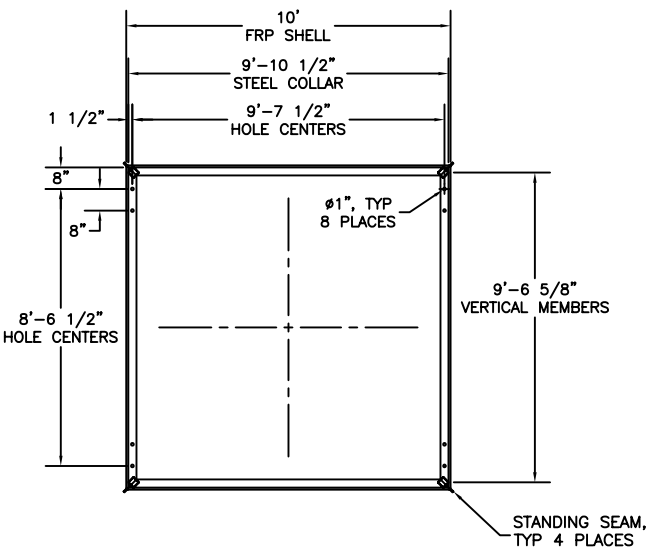

1  
S2 BASE OF CU-705  
PLAN VIEW

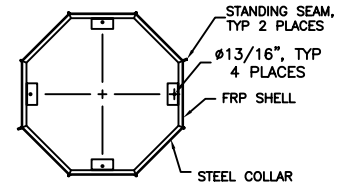

7  
S2 BASE OF SP-728

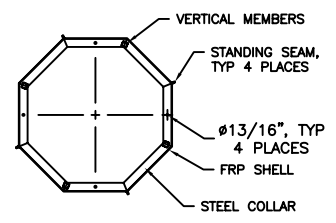

6  
S2 TOP OF CU-701

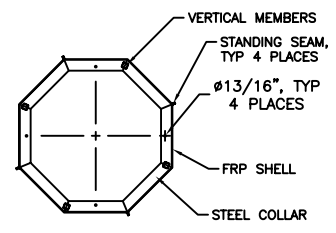

5  
S2 BASE OF CU-701

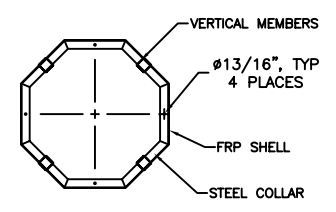

4  
S2 TOP OF CU-409R

P.O. BOX 1340  
HENDERSON, TX 75653-1340  
903/657-6522  
FAX# 903/657-2318

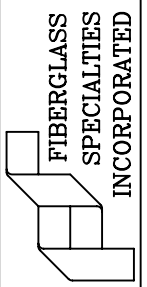

Project: STEEPLE UNIT #39  
SECTION DETAILS

Date: 10-31-05  
Revisions 02-23-06 AGT  
Scale: NONE

Drawing By: AGT  
Checked By:  
File # ALL-STL  
DWG # ST39C2

Sheet#  
S2C  
STRUCTURE